

3M

Compact Wireless Intercom System

Model C960SL

Operating Instructions

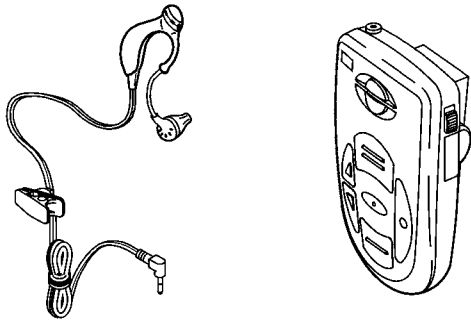

Compact Earset and Transceiver Pack

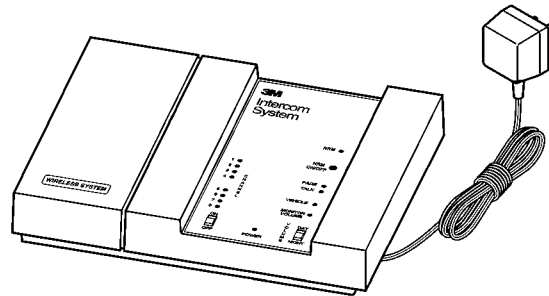

Base Station

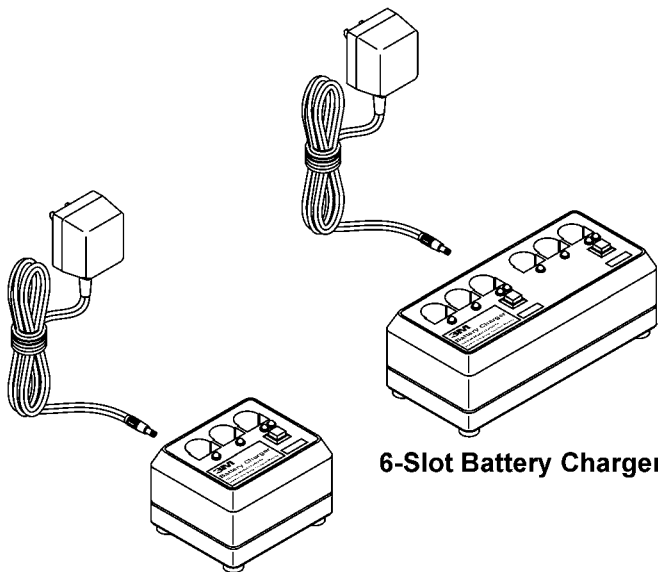

6-Slot Battery Charger

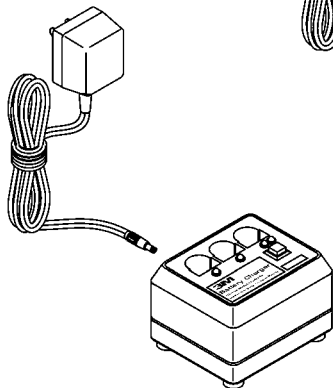

3-Slot Battery Charger

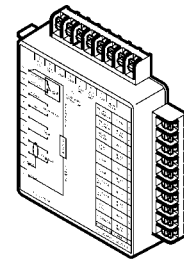

Interconnect Module

Intended Use	iii
FCC Information.....	iii
Service.....	iii
System Descriptions	1
Introduction	1
System Configurations	1
Single-Lane Standard Communication System.....	1
Single-Lane Duplex Communication System.....	1
Dual-Lane Standard Communication System.....	1
Dual-Lane Duplex Communication System.....	1
Cross-Lane Communication System.....	1
System Components.....	2
Base Station.....	2
Compact Earset and Transceiver Pack.....	2
Battery Charger	2
Controls and Indicators.....	3
Base Station.....	3
Compact Earset and Transceiver Pack	4
Battery Chargers.....	6
System Setup.....	7
Introduction	7
Positioning the Earphone.....	7
Connecting the Compact Earset to the Transceiver Pack.....	7
System Operation	8
Introduction	8
Turning On the Base Station.....	8
Turning On the Transceiver Pack.....	8
Operating Modes.....	8
Standby Mode	8
Talk/Listen Mode.....	8
Single-Lane Standard <i>or</i> Duplex Communication Systems	8
Dual-Lane Standard <i>or</i> Duplex Communication Systems.....	8
Cross-Lane Communication Systems.....	9
Talk Lock Mode ("Hands Free").....	9
Page Mode.....	10
Page Monitor Mode.....	10
Special Considerations	11

Maintenance.....	12
Transceiver Pack	12
Replacing the Battery	12
Battery Charger	13
Location.....	13
Cleaning the Contacts.....	13
Batteries.....	13
Care, Handling and Storage	13
Battery Voltage Low Tone.....	13
Charging Batteries.....	13
Disposing of Batteries	14
Making Sure Batteries are Ready for Use	14
Important Information about C960SL Rechargeable Batteries	15
Special Instructions for System Manager	15
Programming the Transceiver Pack for Cross-Lane Operation.....	15
Reprogramming.....	15
Changing Channels if Interference is Heard.....	16
Changing the Day/Night Switch Setting	17
Adjusting the Monitor Speaker Volume.....	18
Troubleshooting.....	18
Introduction	18
System Troubleshooting	18
Battery and Battery Charger Troubleshooting.....	20

Intended Use

The 3M Headset Intercom System, Model C960SL, is designed to provide 2-way radio-frequency audio communication in quick service drive-through restaurants and convenience stores.

Misuse of the Model C960SL could result in poor performance and/or undesired operation.

FCC Information

This device complies with part 15 of the FCC Rules. Operation is subject to the following two conditions: (1) This device may not cause harmful interference, and (2) this device must accept any interference received, including interference that may cause undesired operation.

Changes or modifications not expressly approved by the party responsible for compliance could void the user's authority to operate the equipment.

Service

Model C960SL system service needs can be fulfilled by your local 3M Food Services Trade Department dealer. If special service assistance or information is needed, please call **1-800-328-0033**.

(Blank Page)

Introduction

The 3M Model C960SL Wireless Intercom System is designed for high reliability, compactness, and ease of service.

The system can be programmed to operate on any one of eight different radio channels to provide high-quality audio performance and reduce the possibility of interference between neighboring wireless systems.

System Configurations

The system can be configured in one of five ways depending on the number of menu signs (lanes) at the facility and the type of communication desired.

Single-Lane Standard Communication System

The *single-lane standard communication system* provides standard communication (talk or listen) for facilities that have one menu sign.

The system consists of one base station and one or more transceiver packs and battery chargers.

Single-Lane Duplex Communication System

The *single-lane duplex communication system* provides duplex communication (simultaneous talk *and* listen) for facilities that have one menu sign.

The system consists of one base station and one or more transceiver packs and battery chargers.

Dual-Lane Standard Communication System

The *dual-lane standard communication system* provides standard communication (talk *or* listen) for facilities that have two menu signs.

The system consists of two independent systems - one dedicated to menu sign 1 and the other dedicated to menu sign 2. The transceiver packs are programmed to work with one system or the other and are labeled accordingly (1 or 2).

Dual-Lane Duplex Communication System

The *dual-lane duplex communication system* provides duplex communication (simultaneous talk *and* listen) for facilities that have two menu signs.

The system consists of two independent systems - one dedicated to menu sign 1 and the other dedicated to menu sign 2. The transceiver packs are programmed to work with one system or the other and are labeled accordingly (1 or 2).

Cross-Lane Communication System

The *cross-lane communication system* provides duplex communication (simultaneous talk *and* listen) for facilities that have two menu signs.

The system consists of two duplex systems that are connected to a cross-lane module. The transceiver packs are programmed for either lane 1 or lane 2.

During *off-peak* hours, the cross-lane module can be turned ON to link the two systems and enable one operator to simultaneously talk *and* listen to customers at menu sign 1 or menu sign 2 or with other earset operators.

During *peak* hours, the cross-lane module can be turned OFF to separate the systems and enable menu sign 1 operators to talk to customers at menu sign 1, and menu sign 2 operators to talk to customers at menu sign 2.

The number of system components and the procedures necessary to operate them vary depending on the system configuration. However, three

System Components
Base Station

components are common to all system configurations.

The base station is the interface between the customer and the transceiver pack worn by the operator. See Figure 1.

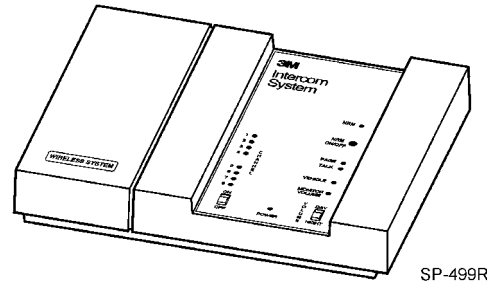

SP-499R

Figure 1. Base Station

Compact Earset and Transceiver Pack

The transceiver pack is used by the operator to communicate with customers and with other store personnel who are wearing transceiver packs and compact earsets.

The compact earset is connected by a communications cable to the battery-powered transceiver pack. See Figure 2.

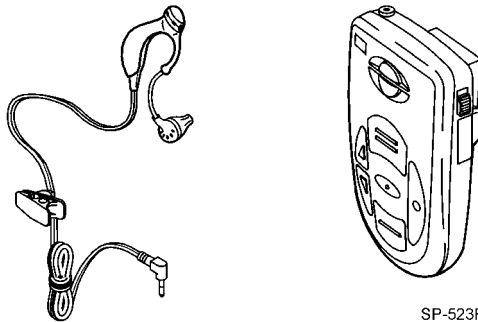

SP-523R

Figure 2. Compact Earset and Transceiver Pack

Battery Charger

The battery charger charges batteries in approximately 1.5 to 2 hours. The charger is available in 3-slot and 6-slot versions. See Figure 3.

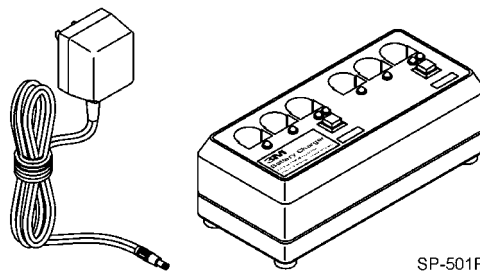

SP-501R

Figure 3. 3-Slot and 6-Slot Battery Chargers

Base Station

The base station controls and indicators are shown below.

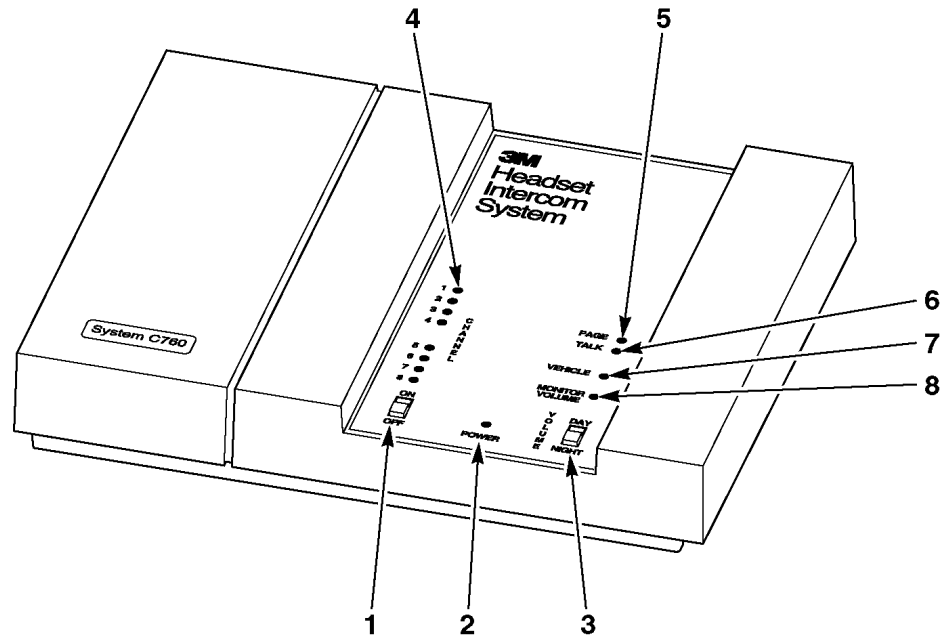

SP-279A

Figure 4. Base Station Controls and Indicators

1 ON/OFF Switch

The ON/OFF switch controls power to the base station.

2 POWER Indicator

This indicator lights when the ON/OFF switch is in the ON position.

✓ Note

If for some reason the C960SL Compact Wireless System does not operate and the system includes an optional wired backup system, turn off the C960SL Base Station to enable the backup system.

3 VOLUME DAY/NIGHT Switch

With the switch in the DAY position, the volume of the menu sign speaker is increased for daytime operation. With the switch in the NIGHT position, the volume of the menu sign speaker is decreased for nighttime operation. (Sound travels further and more efficiently at night.)

4 Channel Indicators

These indicators light to show which of the 8 radio channels is selected.

5 Page Indicator

This indicator lights when Page communications occur.

6 Talk Indicator

This indicator lights when "Talk" communications occur.

7 Vehicle Indicator

This indicator lights when a vehicle is detected.

8 Monitor Volume Access

This access hole allows for adjusting the volume of an optional monitor speaker.

Compact Earset and Transceiver Pack

The controls on the transceiver pack are shown below.

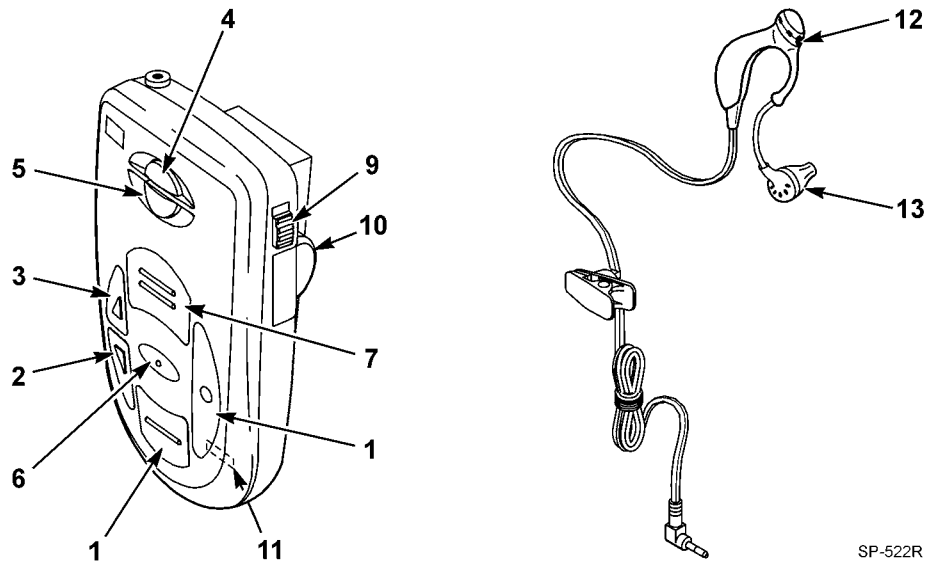

Figure 5. Compact Earset and Transceiver Pack Controls

1 PAGE Switch

Press and hold the PAGE switch to talk to internal personnel without being heard by the customer. Release the switch to listen.

2 Volume Down ▼ Control

Press the volume ▼ down control to decrease the volume.

When either volume control is pressed, the compact earset emits a short tone to indicate the new volume level. There are 15 different volume levels from minimum to maximum.

If the compact earset volume is at its maximum level, a low, continuous tone sounds when the volume up ▲ control is pressed. A low, continuous tone also occurs when the volume reaches minimum level and the volume down ▼ control is pressed.

Note that even when set to its lowest level, compact earset volume is not turned completely off.

3 Volume Up ▲ Control

Press the volume up ▲ control to increase the volume in the compact earset.

4 ON Switch

Press the ON switch to turn on the transceiver pack.

5 OFF Switch

Press the OFF switch to turn off the transceiver pack.

6 Talk Lock Switch (Hand Free)

For duplex systems where hands free operation is desired, press the talk lock switch once to talk and listen to the customer. This enables hands-free operation

SP-522R

- 7 T2 (Talk Lane 2) Switch** For dual-lane systems, press and hold the **T2 (Talk Lane 2)** switch to talk to the customer at the menu sign in lane 2. Release the switch to listen.
For single-lane systems, both switches operate identically.
- 8 T1 (Talk Lane 1) Switch** Press and hold the **T1 (Talk Lane 1)** switch to talk to the customer in lane 1. Release the switch to listen.
- 9 Battery Release** Push the battery release toward the center of the unit to release the battery.
- 10 Battery** This rechargeable battery provides power to the transceiver pack.
- 11 Programming Jack** This jack accepts the programming cable from the base station to allow the transceiver pack to be programmed to the same radio channel as the base station.
- 12 Microphone** The microphone sends the operator's voice to the customer and/or other compact earset operators.
- 13 Earphone** The *earphone* is a speaker that broadcasts the voice from the customer or other compact earset operators. The replaceable earphone cover protects the earphone and cushions the operator's ear to provide comfort.

Battery Chargers

The 3-slot and 6-slot battery charger controls are shown below.

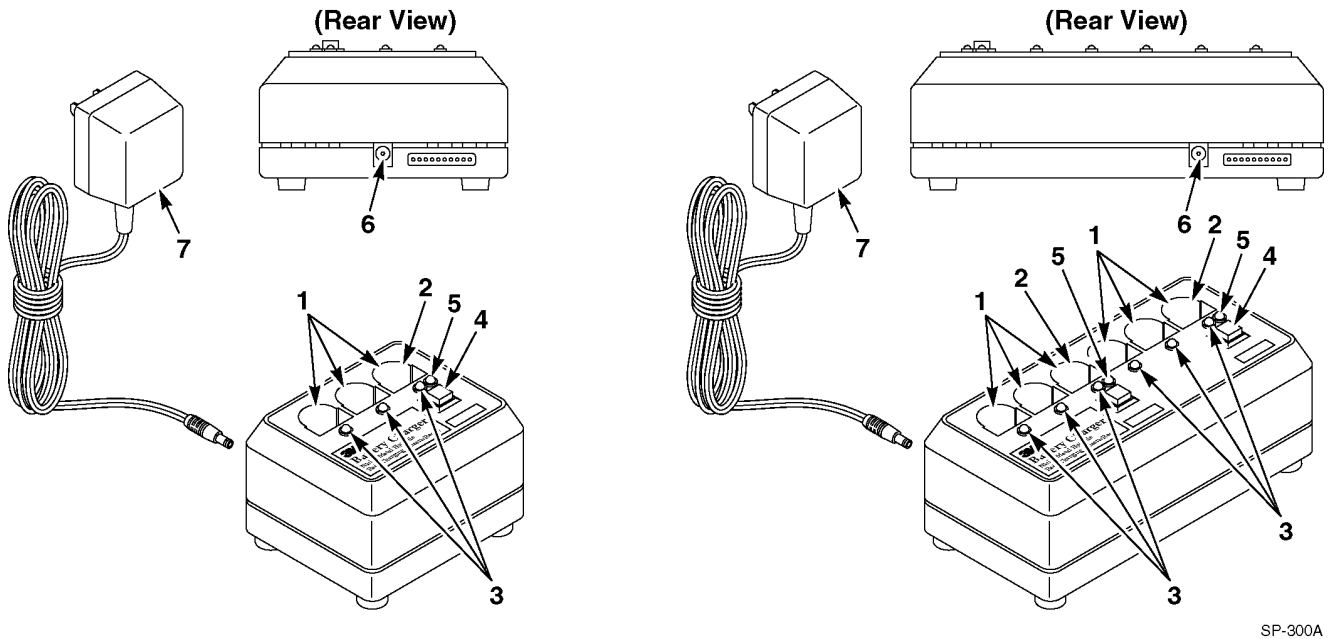

SP-300A

Figure 6. Battery Charger Controls

- | | |
|--|---|
| 1 Charging Slots | The charging slots hold batteries during the recharging cycle. |
| 2 Conditioning and/or Charging Slot | This dual-function slot holds a battery during conditioning and recharging cycles. This slot functions as a conditioning slot when the conditioning button is pressed. |
| 3 Charging Status Indicators | The charging status indicators light RED, GREEN, or ORANGE to indicate charging status:

RED indicates the battery is being charged.

GREEN to indicate the battery is fully charged.

ORANGE to indicate the battery is defective. |
| 4 Conditioning Button | Press the conditioning button to condition a battery that is inserted in the conditioning/charging slot. The button must be pressed within 2 seconds of inserting the battery. |
| 5 Conditioning Status Indicator | The conditioning status indicator lights YELLOW to indicate the battery in the conditioning slot is being conditioned. |
| 6 Power Supply Jack | This jack accepts the plug from the power supply cord. |
| 7 Power Supply | The power supply provides power to the battery charger. |

Introduction

To prepare the Compact Wireless System for use, you will need to check the components for proper assembly and operation positioning.

Positioning the Earphone

Position the microphone tip so it points forward and the earphone fits comfortably in your ear. See Figure 7.



Figure 7. Positioning the Earphone

Connecting the Compact Earset to the Transceiver Pack

To connect the compact earset to the transceiver pack:

Insert the communications plug at the end of the compact earset cable into the modular jack in the top of the transceiver pack.

System Operation	System operation includes turning on the base station and each transceiver pack that will be used.
Turning On the Base Station	To turn on the base station: <ol style="list-style-type: none">1. Slide the power ON/OFF switch to/ the ON position. Check to see that the POWER indicator lights.2. Slide the VOLUME switch to the desired position (DAY or NIGHT).
Turning On the Transceiver Pack	To turn on the transceiver pack, press the ON switch located on the transceiver pack. A single tone will sound in the compact earset to indicate the unit has been turned on.
Operating Modes	The system has several operating modes. The number of available operating modes depends on the system configuration (<i>single-lane vs dual-lane, standard communication vs duplex communication, etc.</i>).
Standby Mode	In the standby mode, the transceiver pack is on and waiting to receive communication from the customer or other compact earset operators. This mode is available with all system configurations.
Talk/Listen Mode	Use the talk/listen mode to talk to the customer. This mode is available with all system configurations. Single-Lane Standard <i>or</i> Duplex Communication Systems <ol style="list-style-type: none">1. A <i>single beep</i> alert tone sounds in the headset at 2-second intervals when the system detects a customer (vehicle) at the menu sign.2. When you hear the alert tone, press and hold T1 <i>or</i> T2 to talk to the customer at the menu sign. Release T1 <i>or</i> T2 to listen. Dual-Lane Standard <i>or</i> Duplex Communication Systems <p>In dual-lane systems, some transceiver packs are programmed to communicate with Lane 1 and others are programmed to communicate with Lane 2.</p> <ol style="list-style-type: none">1. An alert tone sounds in the headset when the system detects a customer (vehicle) at the menu sign:<ul style="list-style-type: none">• The alert tone for Lane 1 compact earsets is a single beep that repeats at 2-second intervals.• The alert tone for Lane 2 compact earsets is a double beep that repeats at 2-second intervals.2. When you hear the <i>single beep</i> alert tone, press and hold T1 and talk to the customer. Release T1 to listen. When you hear the <i>double beep</i> alert tone, press and hold T2 to talk to the customer. Release T2 to listen.

System Operation

Cross-Lane Communication Systems

Communication During Peak Hours

During peak hours, the cross-lane module is turned *off* and the system functions like a dual-lane duplex system. Some transceiver packs are programmed to communicate with Lane 1 and others are programmed to communicate with Lane 2.

Communication During Off-Peak Hours

During off-peak hours, the cross-lane module is turned *on* to enable a single operator to communicate with customers in either lane (*1 or 2*).

1. An alert tone sounds in the compact earset when the system detects a customer (vehicle) at the menu sign:
 - The alert tone for Lane 1 transceiver packs is a single beep that repeats at 2-second intervals.
 - The alert tone for Lane 2 transceiver packs is a double beep that repeats at 2-second intervals.
2. When you hear the *single beep* alert tone, press and hold T1 and talk to the customer at menu sign 1. Release T1 to listen.

When you hear the *double beep* alert tone, press and hold T2 to talk to the customer at the menu sign 2. Release T2 to listen.

Talk Lock Mode ("Hands Free")

Use this mode to operate "hands free". The talk lock mode is only available with duplex system configurations.

In this mode, the transceiver pack automatically switches from standby to talk/listen when a customer is detected. The transceiver pack automatically switches back to standby when the customer leaves.

✓ **Note**

"Hands Free" operation (talk lock mode) prevents all other compact earset operators from communicating.

To use the talk lock mode, press the talk lock switch on the transceiver pack. To return to normal operation, press T1 or P.

Page Mode

Use this mode to talk to other operators who are wearing compact earsets without being heard by the customer at the menu sign. This mode is available with all system configurations.

To page another operator, press and hold the page switch while speaking. Release the page switch to listen.

✓ Note

If you are **not** a menu sign operator, do not use the page mode while the menu sign operator is communicating. Doing so may interrupt or prevent communication between the menu sign operator and the customer.

Page Monitor Mode

Use this mode to listen for pages from other operators (without hearing the communication to and from the customer). This feature is convenient for managers who only want to hear page communication. This mode is available with all system configurations.

To use the page monitor mode:

1. Turn the transceiver pack OFF. See Figure 8.

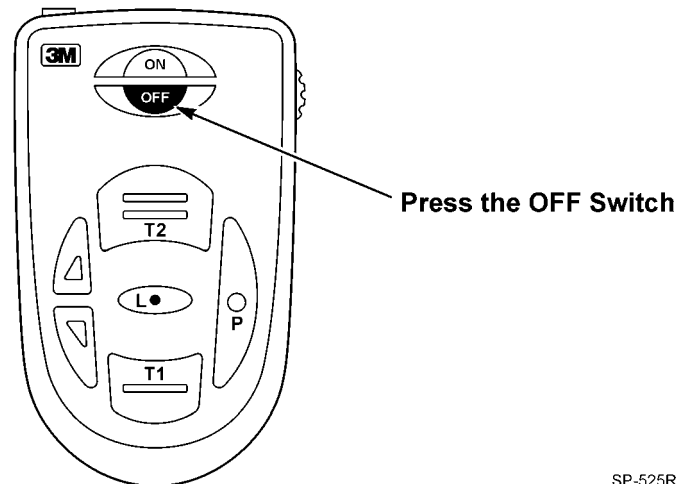

SP-525R

Figure 8. OFF Switch

2. While pressing and holding the page switch, turn the transceiver pack ON. This locks the transceiver pack in the page monitor mode. See Figure 9 on the next page.

System Operation

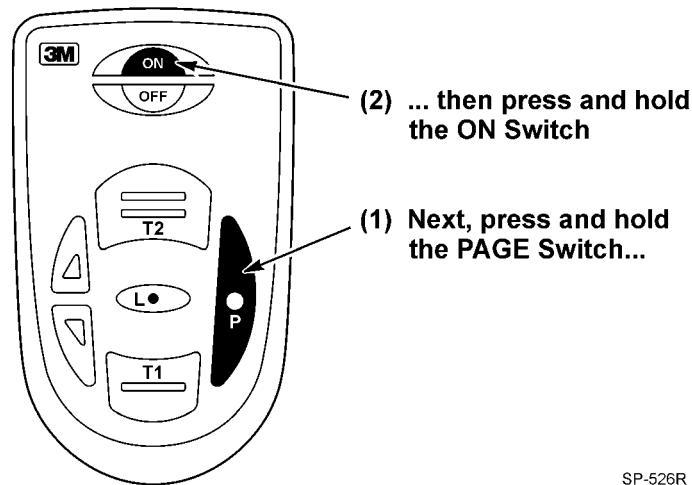

SP-526R

Figure 9. PAGE Switch and ON Switch

To respond to a page, press PAGE.

To return to normal operation:

1. Turn the transceiver pack OFF.
2. Turn the transceiver pack ON.

Special Considerations

When using the talk/listen mode or the page mode, keep the following things in mind:

- Communication between the operator and the customer may be heard by several people.
- Only one operator can talk at a time.
- In the talk/listen mode, communication **from the transceiver pack** is heard by customers and other operators who are wearing compact earsets.

Transceiver Pack

Replacing the Battery

When the battery voltage is too low, the compact earset sounds a short, low-volume tone at seven-second intervals to alert the operator to install a fully charged battery. The "battery voltage low tone" continues for two minutes after which the transceiver pack turns off automatically to prevent damage to the batteries.

✓ **Note**

When installing a battery, make sure it is fully charged. It is important to remember that an unused C960SL battery loses five percent of its charge per week. If a battery has not been used for several weeks, make sure to charge prior to use.

To replace the battery:

1. Push the battery release to release the battery. See Figure 10.
2. Remove the discharged battery from the transceiver pack.
3. Insert a **fully charged battery** in the unit. Make sure the battery is fully inserted (battery release clicks). See Figure 10.

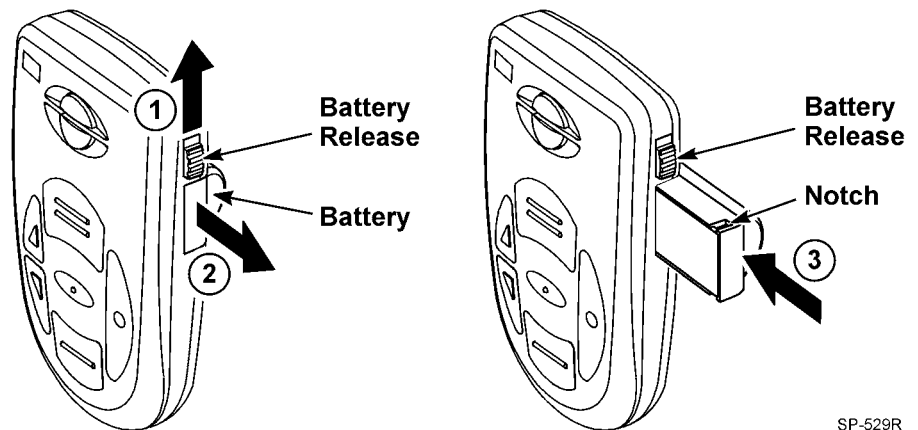

SP-529R

Figure 10. Replacing the Batteries

Battery Charger

Location

The battery charger should be placed on a flat surface such as a desktop or table in a clean, dry environment, or an optional wall mount unit may be used.

Cleaning the Contacts

If the indicators fail to light during charger operation, clean the contacts using an alcohol-moistened cotton swab.

Batteries

Care, Handling and Storage

Avoid dropping batteries. Do not carry batteries in your pockets or leave them in hot, damp or dirty places.

⚠ Caution
Be careful not to short the battery contacts together.

Battery Voltage Low Tone

When the battery voltage becomes too low, a short, low-volume tone sounds in the headset at seven-second intervals to alert the operator to replace with a fully charged battery.

The "battery voltage low tone" continues for two minutes after which the headset turns off automatically to prevent damage to the batteries.

Charging Batteries

To charge a battery, insert the battery in one of the charging slots as shown in Figure 11.

- The indicator lights RED to indicate the battery is charging.
- The indicator lights GREEN to indicate the battery is fully charged.
- The indicator lights ORANGE to indicate the battery is defective.

✓ Note

Discharged batteries require 1-1/2 to 2 hours to charge.

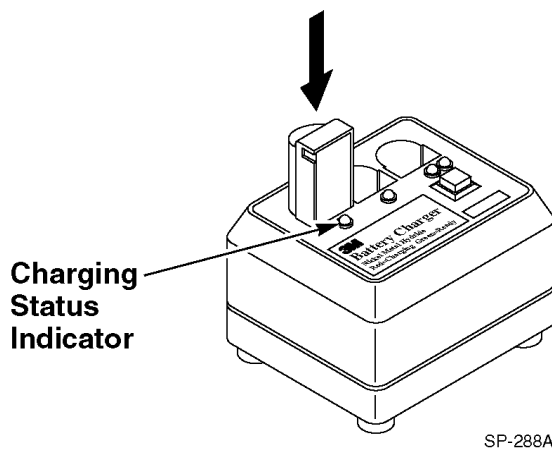

Figure 11.

To condition a battery:

1. Insert the battery in the charging/conditioning slot as shown in Figure 12.
2. Press the conditioning button within 2 seconds after inserting the battery. The indicator lights YELLOW to indicate the battery is being conditioned.
3. When the conditioning cycle ends, the Conditioning Status Indicator will glow green.

✓ Note

Conditioning leaves the battery in a charged state.

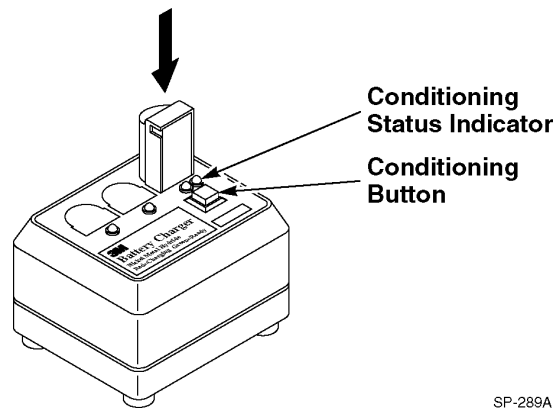

SP-289A

Figure 12.**Disposing of Batteries**

To help protect the environment, C960SL rechargeable batteries which have reached the end of their useful life should be disposed of in accordance with local requirements.

Making Sure Batteries are Ready for Use

Follow these tips to make sure batteries are always ready for use:

- Have at least one extra battery for each belt pack. This helps ensure that a fully charged battery is always available.
- Recharge a low battery as soon as it is removed from the transceiver pack.
- Keep the battery contacts clean: both those on the battery and those in the belt pack. To clean the contacts, use an alcohol-moistened cotton swab.
- Remember that a battery recharge takes approximately 1-1/2 to 2 hours.
- Avoid removing and reinserting batteries while they are charging (charging status indicator is RED).
- Remember that batteries discharge fastest during Talk and Page operation. Avoid unnecessary communications.

**Important Information
about C960SL
Rechargeable Batteries**

Keep the following information in mind as you operate the system and as you establish operating procedures:

- Avoid shorting across the battery contacts with metal items. Never carry a battery in a pocket or place it in a drawer where it can accidentally be shorted by keys, coins etc.
- Have adequate charging capacity for the number of transceiver packs in your system. One battery charger will handle up to three transceiver packs. Use of more than three transceiver packs requires an additional battery charger.
- Batteries perform best at moderate temperatures. Extremes of heat and cold reduce their performance.

**Programming the
Transceiver Pack for
Cross-Lane Operation**

The transceiver packs are factory programmed for single-lane operation to enable the operator to press either T1 or T2 to communicate with lane 1.

For cross-lane systems, the transceiver packs must also be programmed to enable communication with either lane 1 *or* lane 2. With the cross-lane module turned ON, the lane 1 **or** lane 2 operators can press T1 to talk to lane 1 customers or T2 to talk to lane 2 customers.

To program the transceiver pack for cross-lane operation:

- While pressing and holding *both* the T1 and T2 switches on the transceiver pack, turn the unit ON. Hold all three switches for at least 5 seconds. See Figure 13.
- Audible tones will be heard in the compact earset earphone, indicating that the transceiver pack is programmed for cross-lane operation.

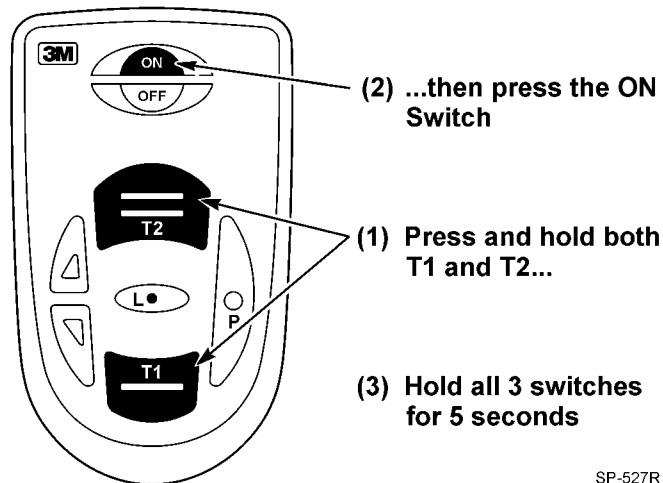

SP-527R

Figure 13.

Reprogramming

If you no longer need the cross-lane feature, reprogram the transceiver pack by repeating the above procedure.

Changing Channels if Interference is Heard

The C960SL system is capable of operating on any one of eight different channels. If messages etc. from a different transmitter are heard in the compact earset or monitor speaker, or if you are told that your store's messages are being heard elsewhere, interference is occurring. You can correct either type of interference by changing the base station operating channel. To do this:

1. Pull outward on the right side of the base station half-cover and then lift and remove the cover. See Figure 14.

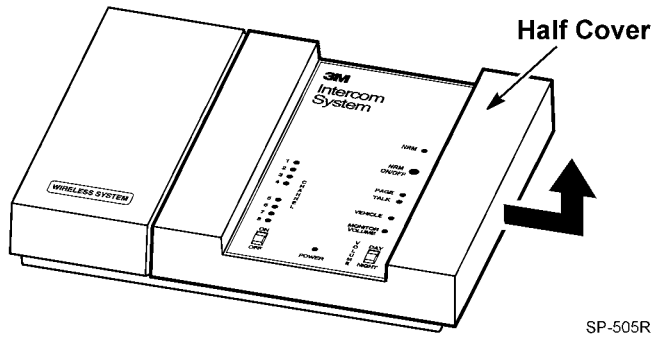

Figure 14.

2. With the base station turned on, press and release the Channel Select switch once. (This advances the system to the next channel.) One of the red indicators (1-8) will light, indicating the newly selected channel.

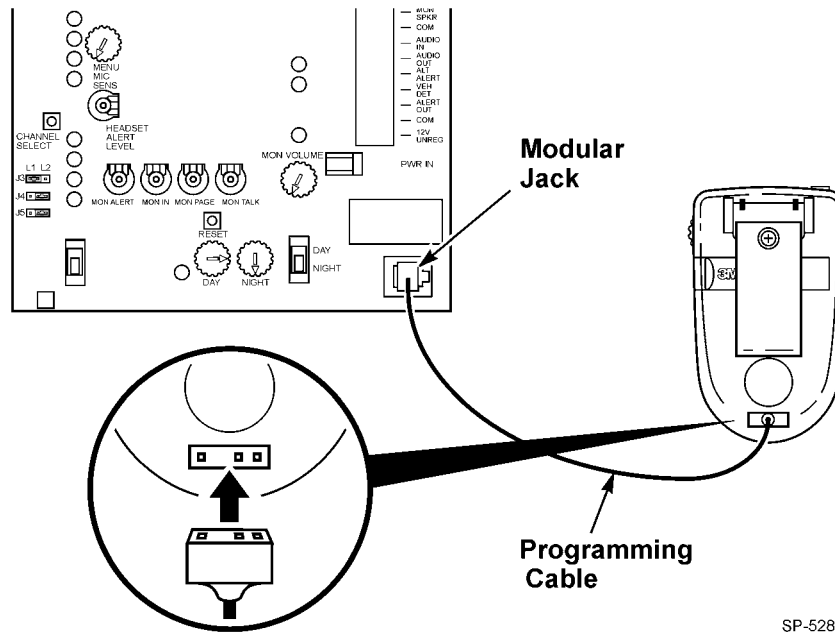

Figure 15.

✓ Note

When two systems are used in a cross-lane application, both base stations must be set to the same channel, but different lane settings.

3. With the transceiver pack turned OFF, plug one end of the programming cable into the transceiver pack programming jack. See Figure 15.
4. Plug the other end of the programming cable into the base station programming jack. See Figure 15.
5. Turn the transceiver pack ON. Audible tones will be heard in the compact earset earphone, indicating that programming is complete.
6. If the transceiver pack is used in a cross-lane system, the transceiver pack must also be programmed for cross-lane operation:
 - a. Turn the transceiver pack OFF.
 - b. While pressing and holding *both* T1 and T2 on the transceiver pack, turn the transceiver pack ON. Hold all three switches for at least 5 seconds. See Figure 13.
 - c. Audible tones will be heard in the compact earset earphone, indicating that programming is complete.
7. Repeat Steps 1 through 6 to program the rest of the transceiver packs.

The transceiver pack is now programmed to the same channel as the base station. If interference continues to occur, repeat the channel programming procedure. After seven channel changes, the original channel will again be encountered. If none of the channels is interference-free, contact your local 3M InTouch Products dealer.

Changing the Day/Night Switch Setting

Outdoors, sound travels best at night when air temperatures are cooler and background noise is reduced. To allow you to reduce the volume of the menu sign speaker to a lower, pre-set nighttime level, the base station has a VOLUME DAY/NIGHT switch. See Figure 16.

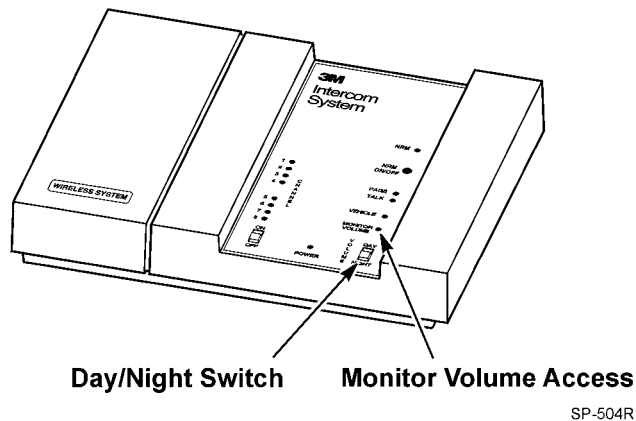

Figure 16.

Normally, the VOLUME DAY/NIGHT switch is always left in the DAY position. However, if local ordinances require quieter nighttime operation of the menu sign, move the VOLUME DAY/NIGHT switch to the NIGHT position.

Adjusting the Monitor Speaker Volume

If the system has an optional monitor speaker, adjust its volume using the following procedure:

1. With the base station turned ON, insert a small straight-blade screwdriver into the MONITOR VOLUME access hole. See Figure 16.
2. Turn the volume control clockwise to increase the volume or counterclockwise to decrease it.

Introduction

To use the following troubleshooting guide, locate the problem in the left column and look for the problem's possible causes and corrections in the middle and right columns. Possible causes are listed in the order in which they are most likely to happen. Check for possible causes in the given sequence to help isolate the problem.

System Troubleshooting

Problem	Possible Cause	Correction
No communications. One or more headsets hear static.	The base station is not ON. Base station and transceiver packs not programmed to same channel. The base station is defective.	Turn the base station ON. Make sure that the power transformer is plugged into the wall outlet <u>and</u> into the base station power receptacle. If the red power light does not come on, check for power at the wall outlet. If power is OK, call for authorized service. Reprogram base station and/or transceiver packs. Call for authorized service.
A single transceiver pack is dead. No communication to or from customer. No communications to or from other transceiver packs (PAGE or TALK functions). No static is heard.	The transceiver pack is not turned on. The battery is discharged. The compact earset is unplugged or defective.	Turn the transceiver pack on. Replace the battery with a fully charged one. Call for authorized service.

Problem	Possible Cause	Correction
Transceiver packs do not go into standby (silence) when the vehicle leaves the menu sign.	<p>This is normal when an “air switch” type of vehicle detector is in use.</p> <p>There is a large metal object over the loop in the driveway (if a loop is used).</p> <p>Defective vehicle detector.</p>	<p>Momentarily press the PAGE switch to return to standby.</p> <p>Remove the metal object.</p> <p>Call for authorized service.</p>
The monitor speaker does not operate.	The base station internal monitor volume control is turned too low.	Increase the monitor speaker volume setting (Store manager only).
No vehicle alert tone in headset.	<p>The vehicle detector module is not plugged into the power outlet.</p> <p>The internal base station alert tone volume control is set too low.</p> <p>Defective base station or vehicle detector module.</p>	<p>Plug the vehicle detector module into the power outlet.</p> <p>Call for authorized service.</p> <p>Call for authorized service.</p>
No communication to or from the customer when using the backup intercom.	<p>The base station is not turned OFF.</p> <p>No power to the backup intercom.</p> <p>The volume controls on the backup intercom are turned too low.</p> <p>Defective backup intercom.</p>	<p>Turn the base station OFF.</p> <p>Turn the backup intercom ON and/or plug its power transformer into the wall outlet.</p> <p>Turn the volume controls up to increase volume.</p> <p>Call for authorized service.</p>
“Low battery” tones are heard in compact earset despite newly charged battery.	<p>Dirty contacts on the battery, transceiver pack, or in the battery charger.</p> <p>Defective battery.</p> <p>Defective transceiver pack.</p>	<p>Clean the battery contacts with alcohol.</p> <p>Replace the battery.</p> <p>Call for authorized service.</p>
No TALK or LISTEN with known good transceiver pack.	System problem.	Call for authorized service.
Low volume from transceiver pack to customer and other compact earsets.	Compact earset earphone not positioned properly on operator’s ear.	Reposition earphone (see “Positioning the Earphone” on page 7 for proper placement)

Problem	Possible Cause	Correction
Audio “cuts out” or is interrupted when talking to customer or other compact earsets.	Interference. Transceiver pack is too far from the base station (out of range). Defective transceiver pack or base station.	Change channels and reprogram the transceiver packs. Move closer to the base station. Call for authorized service.
No transmit to menu sign or other transceivers when TALK switch is pressed. PAGE communications OK.	Defective TALK switch or defective base station.	Call for authorized service.
Short repeating tone at seven second intervals heard in compact earset, and then transceiver pack turns off after two minutes.	This is normal operation when the battery voltage becomes too low. Dirty battery contacts.	Recharge battery. Clean battery contacts with alcohol.

Battery and Battery Charger Troubleshooting

Problem	Possible Cause	Correction
Battery does not charge when plugged into battery charger.	Either the battery contacts or the contacts in the battery charger have a dirt/grease buildup. Defective battery. Defective battery charger.	Clean battery/battery charger contacts with alcohol and cotton swab. Try a known good battery. Call for authorized service.
Short battery life.	Battery is/was not fully charged. Dirty battery contacts. Battery needs to be reconditioned.	Recharge battery. Clean battery contacts with alcohol. Recondition battery.
LED does not turn red when a battery is plugged into the battery charger.	Dirty contacts on battery or in battery charger. Battery charger not plugged in. Defective Battery. Defective battery charger.	Clean battery/battery charger contacts with alcohol. Check that the battery charger transformer is plugged in and connected to a “live” outlet. Try a known good battery. Call for authorized service.



Food Services Trade Department

3M Center

St. Paul, MN 55144-1000

Printed in U.S.A.

©3M 2003

78-6912-0747-2 Rev. A